

M8分线盒-8端口-M12接头

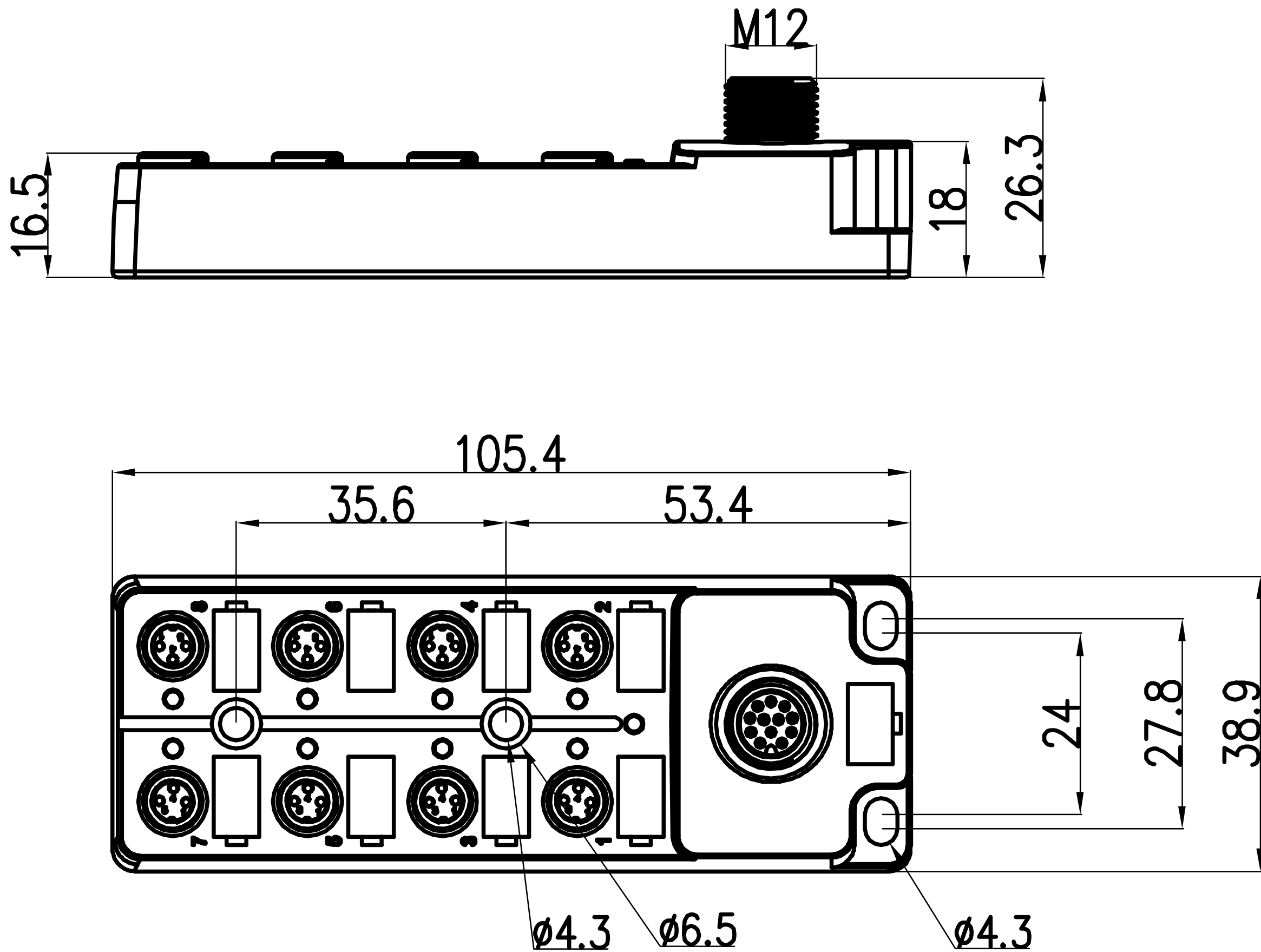

NPN型号

YJ-FXH-8A3F/N8. M12-12

PNP型号

YJ-FXH-8A3F/P8. M12-12

NPN接线图

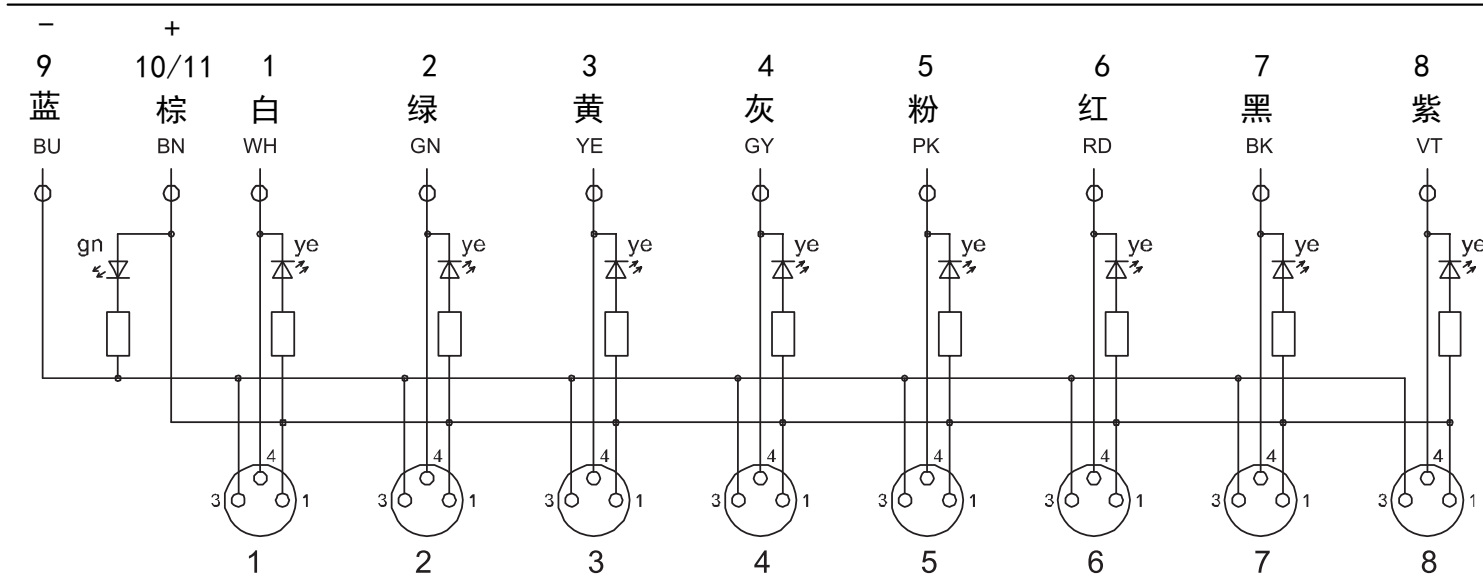

PNP接线图

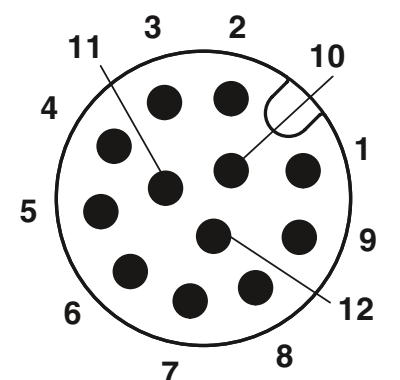
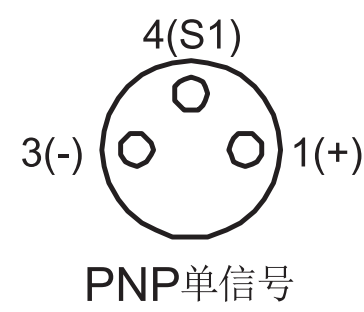
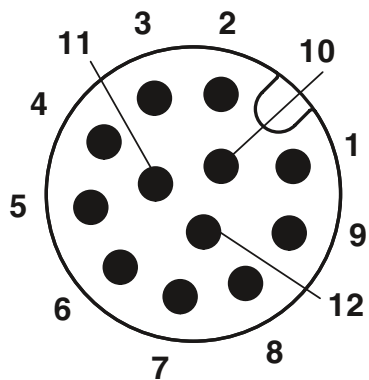
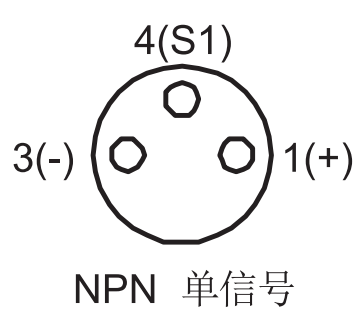
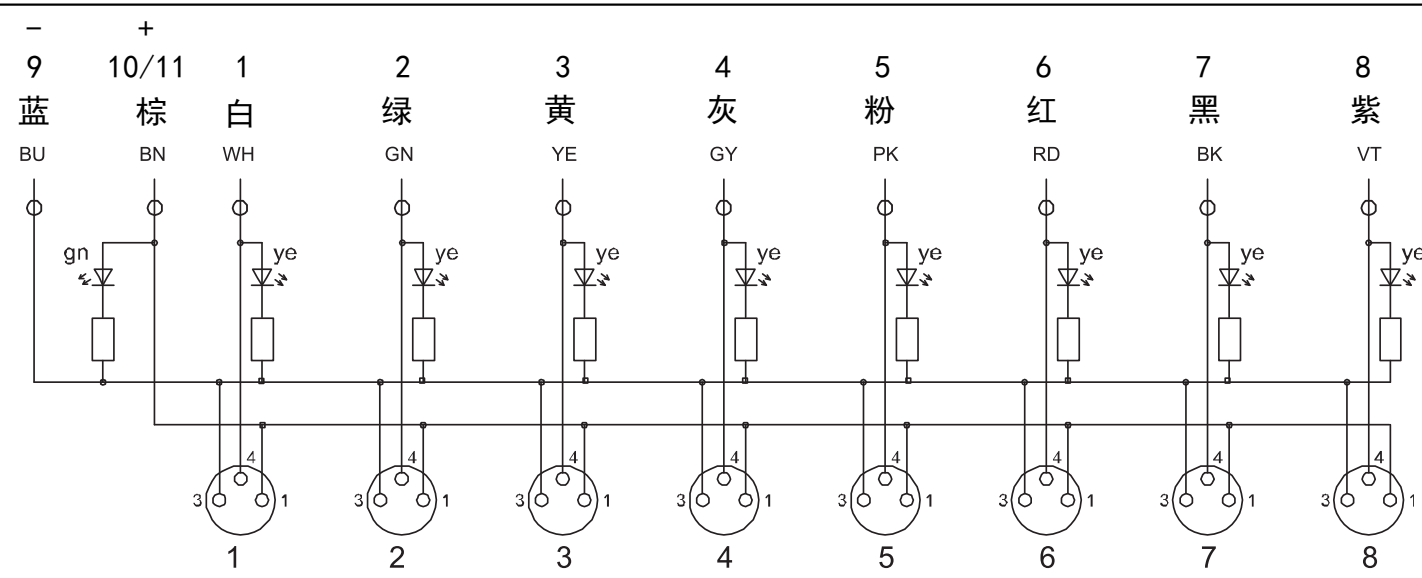

分线盒技术参数

外壳材质	PA66	额定电流	2A	触点电阻	≤3MΩ	接头螺纹	M8x1
锁紧螺母	铜/镀镍	总额定电流	12A	绝缘电阻	≥100MΩ	插拔周期	≥100
防护等级	IP67	额定电压	30V	使用温度	-20°C~+80°C	状态显示	黄YE(Signal信号) 绿GN(Power电源)